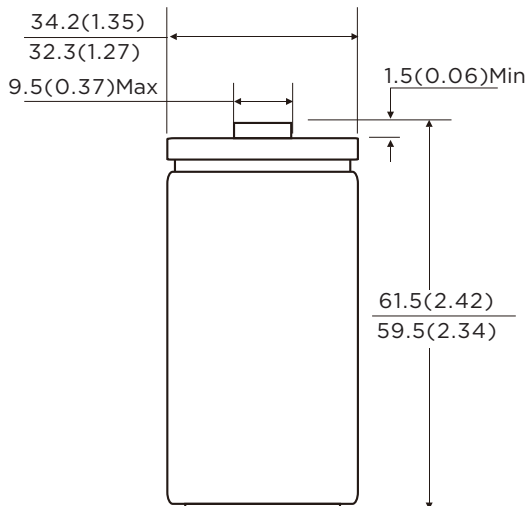

NH-D2500AR
Ni-MH Battery

Dimensions

Specifications

Chemical System:	Nickel Metal Hydride
IEC Name:	HR20M
ANSI/NEDA:	1.2H4(D)
Westinghouse Model:	NH-D2500AR
Average Weight:	86g
Dimension(Ø x H):	33.25 ^{±0.95} x 60.5 ^{±1} mm
	1.31 ^{±0.037} x 2.38 ^{±0.039} inch
Terminals:	Flat
Nominal Voltage:	1.2Volts
Internal Resistance:	33m-ohm
Capacity(500mA constantly discharge to 1.0V at 25±2°C)	
Minimum:	2500mAh
Typical:	2550mAh
Operating Temperature:	-10 °C-50 °C
Storage Temperature:	15 °C-25 °C
Relative Humidity:	60±15%
Jacket :	PVC

Usage Guide

Flash light



Clock



Radio

Cautions
Storage

Store the battery in a cool, dry and well-ventilated area.

Handling

- 1) Do not heat or disposed in fire or water. Do not modify or disassemble the battery. Do not short-circuit positive (+) and negative (-) terminals. Keep away from metal or other conductive materials.
- 2) Keep away from infants. If infant happens to swallow the battery, consult a doctor immediately.
- 3) When the battery is stored or disposed, isolate positive (+) and negative (-) terminals of the battery to avoid those terminals touch each other.
- 4) In case the battery electrolyte happen to come into mouth,gargle well enough and consult a doctor immediately.

Notice:

Environmental elements comply with 2006/66/EC and US LAW 104-142 requirements. This data sheet is typical information specific to products manufactured at the time of its publication. For the latest information, contact us at: info@westinghousebattery.com.

 and WESTINGHOUSE are trademarks of Westinghouse Electric Corporation. Used under license by Camelion Battery, Ltd. All Rights Reserved.

NH-D2500AR
Ni-MH Battery

Storage for 12months

Measurement temperature: $20 \pm 2^\circ\text{C}$

Storage procedure: storage for 12 months, measure the voltage and then perform capacity test

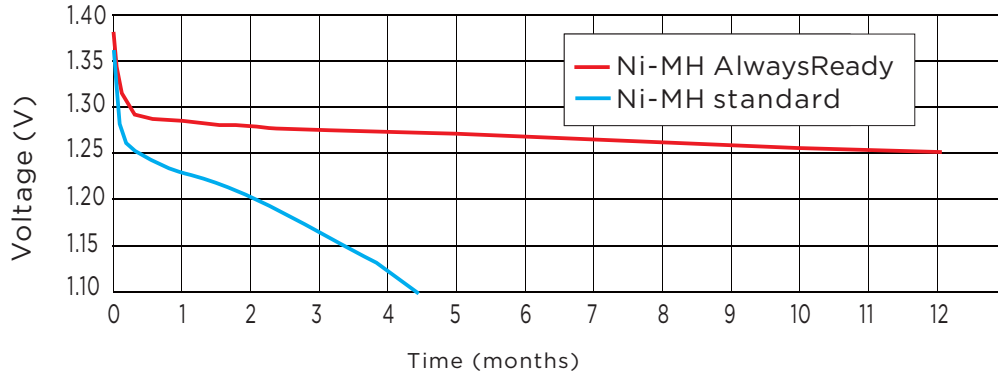

Charge Characteristics

Measurement temperature: $25 \pm 2^\circ\text{C}$

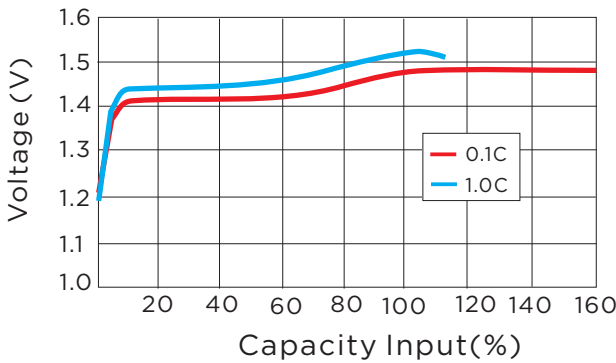

Discharge Characteristics

Measurement temperature: $25 \pm 2^\circ\text{C}$

Charge: $0.1\text{C} \times 16\text{hrs}$

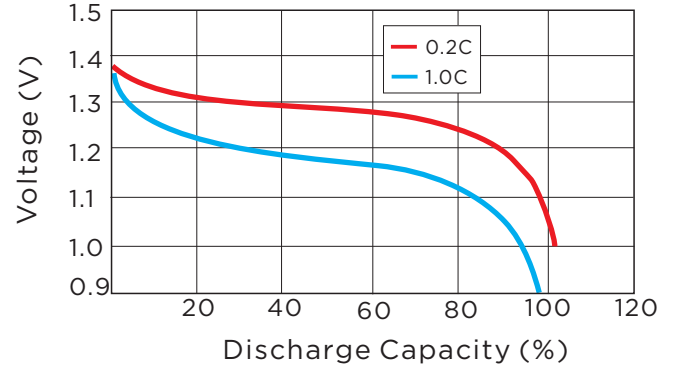

IEC Cycle Life Curve

Measurement temperature: $25 \pm 2^\circ\text{C}$

Procedure: According to IEC61951-2(2011)

7.5.1.2

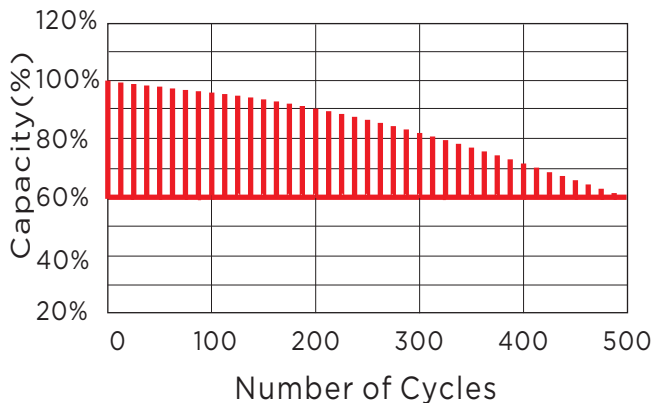

Temperature Characteristics

Procedure: Charge 16hrs by 0.1C ; Rest for 60mins

Discharge to 1.0V by 0.2C

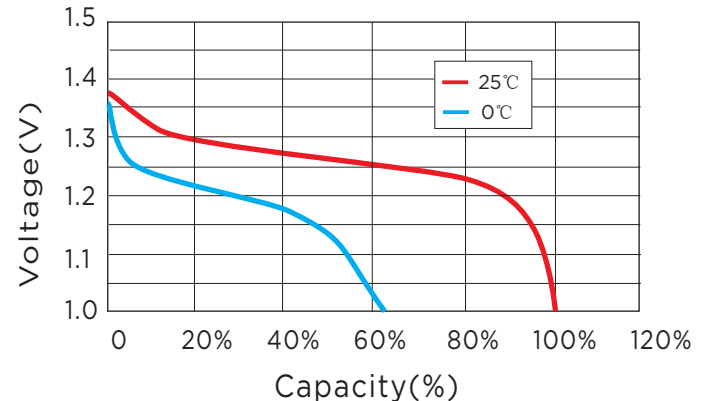

Notice:

Environmental elements comply with 2006/66/EC and US LAW 104-142 requirements. This data sheet is typical information specific to products manufactured at the time of its publication. For the latest information, contact us at: info@westinghousebattery.com.

 and WESTINGHOUSE are trademarks of Westinghouse Electric Corporation. Used under license by Camelion Battery, Ltd. All Rights Reserved.