

## LR57(AG7)

**ZERO MERCURY** Alkaline Button Cell

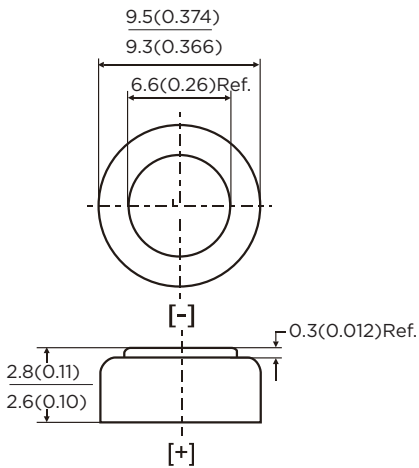

### Dimensions



Unit:mm(inch)

### Specifications

Chemical System:	Alkaline(Zn/MnO <sub>2</sub> ) (Zinc-Manganese Dioxide)
IEC Name:	LR57
Westinghouse Model:	LR57
Average Weight:	0.7g
Dimension(ΦxH)	9.4 x 2.7mm 0.37x 0.11 inch
Terminals:	Flat
Nominal Voltage:	1.5Volts
Capacity:	45mAh (Rated at 15kohm to 0.9V)
Operating Temperature:	-18°C -55°C
Storage Temperature:	15°C -25°C
Relative Humidity:	60±15%

### Usage Guide



Watch



Calliper



Calculator

### Typical Discharge Testing

Typical characteristics at 21°C

