

LR20(13A)

Alkaline Battery

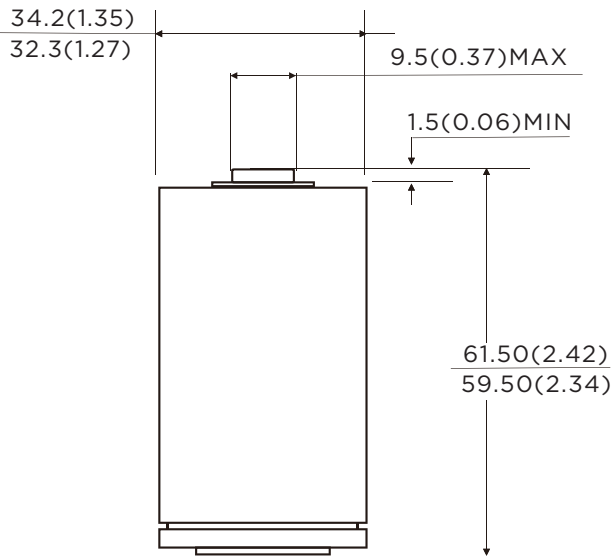

Dimensions



Unit:mm(inch)

Specifications

Chemical System:	Alkaline (Zn/MnO ₂) Zinc-Manganese Dioxide
IEC Name:	LR20
ANSI/NEDA:	13A(D)
Westinghouse Model:	LR20
Average Weight:	140g
Dimension(Ø x H):	33.25 ^{±0.95} x 60.5 ^{±1} mm 1.31 ^{±0.04} x 2.38 ^{±0.04} inch
Terminals:	Flat
Nominal Voltage:	1.5Volts
Capacity:	20000mAh (Rated at 25mA to 0.8V)
Operating Temperature:	-18°C-55°C
Storage Temperature:	15°C-25°C
Relative Humidity:	60±15%
Jacket :	Aluminum Foil Label

Usage Guide



Flash light



Clock

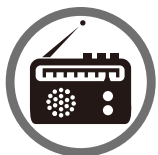

Radio

Cautions

Storage

Store the battery in a cool, dry and well-ventilated area.

Handling

- 1) Never charge the battery. Do not heat or disposed in fire or water. Do not modify or disassemble the battery. Do not short-circuit positive (+) and negative (-) terminals. Keep away from metal or other conductive materials.
- 2) Keep away from infants. If infant happens to swallow the battery, consult a doctor immediately.
- 3) When the battery is stored or disposed, isolate positive (+) and negative (-) terminals of the battery to avoid those terminals touch each other.
- 4) In case the battery electrolyte happen to come into mouth, gargle well enough and consult a doctor immediately.

Notice:

Environmental elements comply with 2006/66/EC and US LAW 104-142 requirements. This data sheet is typical information specific to products manufactured at the time of its publication. For the latest information, contact us at: info@westinghousebattery.com.

, and WESTINGHOUSE are trademarks of Westinghouse Electric Corporation. Used under license by Camelion Battery, Ltd. All Rights Reserved.

LR20(13A)

Alkaline Battery

Constant Current Discharge

Typical Characteristics at 21°C

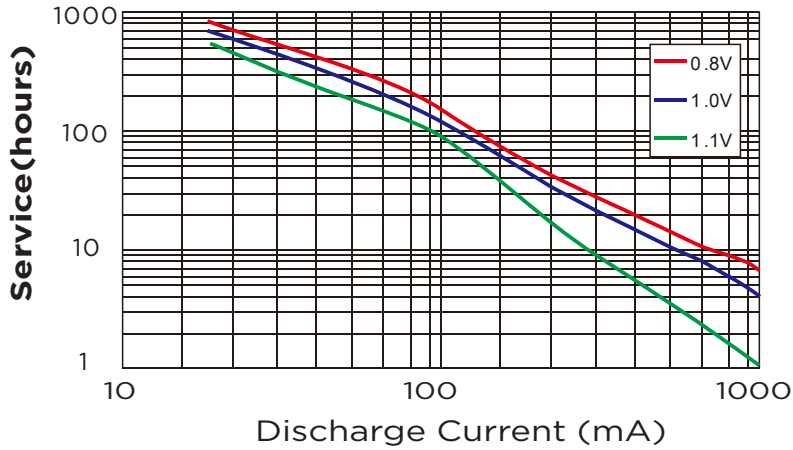

ANSI/IEC Standard Testing

Typical Characteristics 21°C

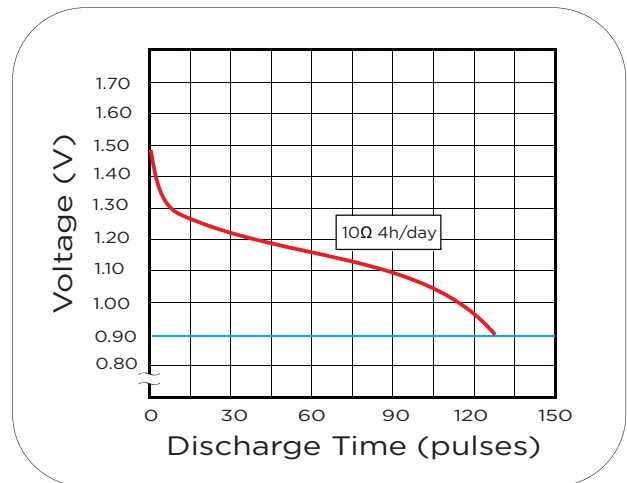
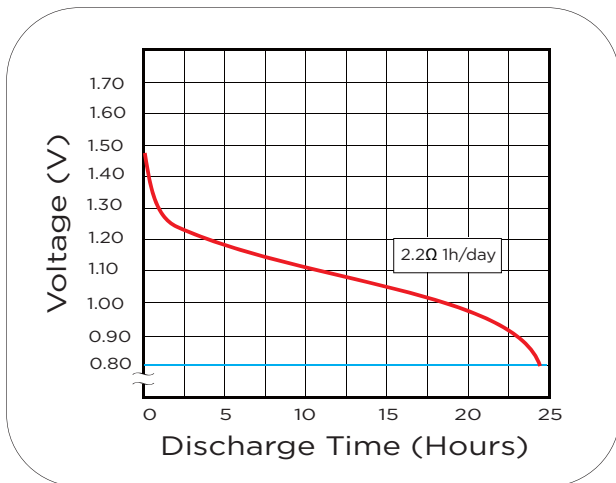
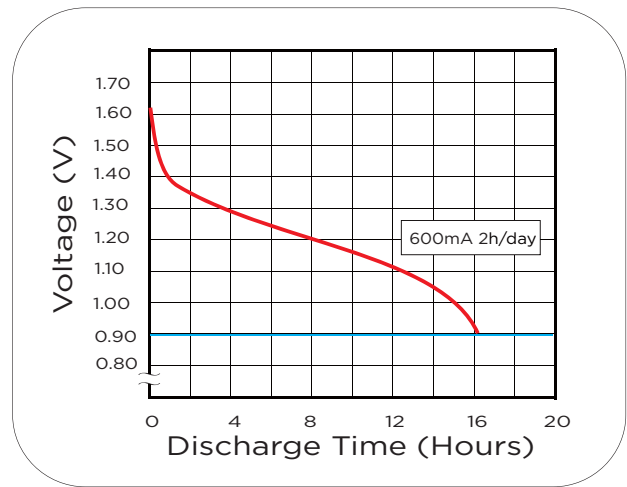
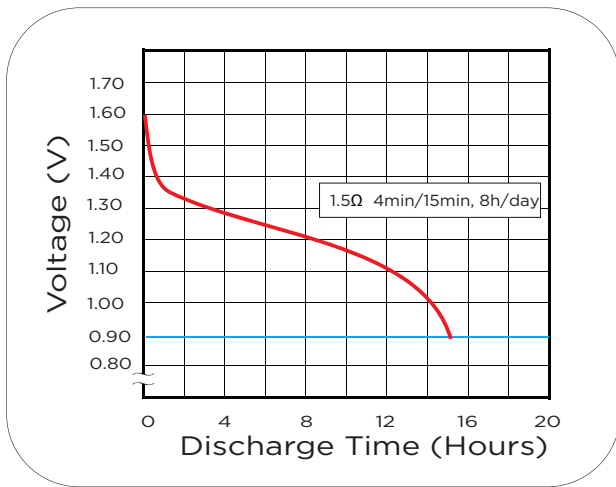

Notice:

Environmental elements comply with 2006/66/EC and US LAW 104-142 requirements. This data sheet is typical information specific to products manufactured at the time of its publication. For the latest information, contact us at: info@westinghousebattery.com.

 and WESTINGHOUSE are trademarks of Westinghouse Electric Corporation. Used under license by Camelion Battery, Ltd. All Rights Reserved.